



**STARSCREAM**  
MMS472



TRANSFORMERS and all related characters are trademarks of Hasbro and are used with permission. © 2022 Hasbro. All Rights Reserved. Licensed by Hasbro.



It is highly recommended that you visit [www.metalearth.com/360/mms472](http://www.metalearth.com/360/mms472) to see the completed model before assembling your own

## TO CREATE THE BEST CONNECTIONS

A - 56

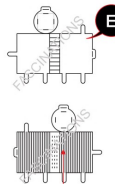

Consider these engraved stripes as supporting features for the bend

A - 6

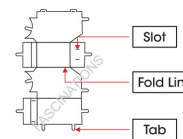

### Legends:

- Engraved/ Color side
- Non - engraved/ Silver side
- Attention point
- Insert tab and bend 90 degrees
- Insert tab and twist 90 degrees

### Recommended tools:

- Wire cutters: helpful for taking parts from the metal sheets.
- Tweezers or needle nose pliers: helpful for folding parts, bending and twisting tabs.

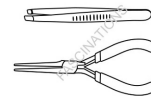

### Assembly tip:

If needed, slightly twist tabs to hold parts together then untwist and bend them down for a nice finish.



In order to avoid possible injury from sharp edges, please carefully discard the metal sheets after parts have been removed.

## METAL SHEETS

Parts with same color are duplicates

A



B

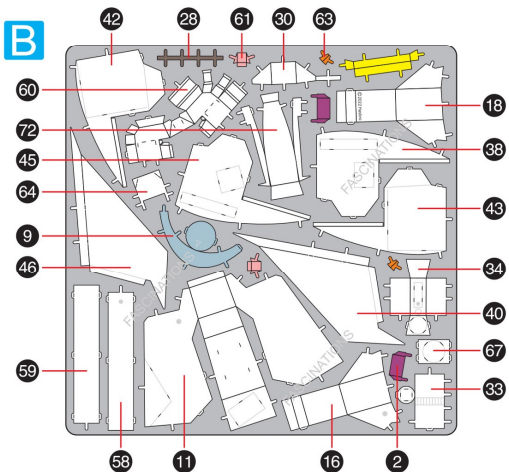

C

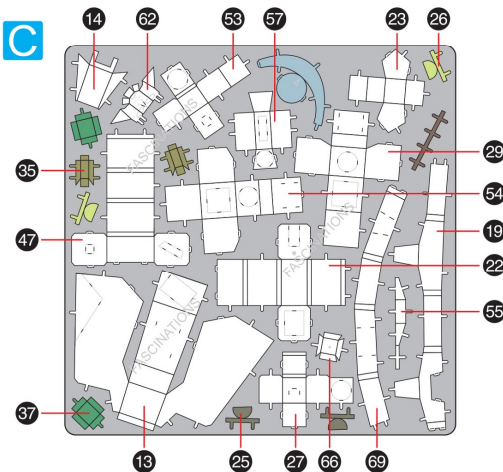

## ASSEMBLY FLOW CHART

Step 1

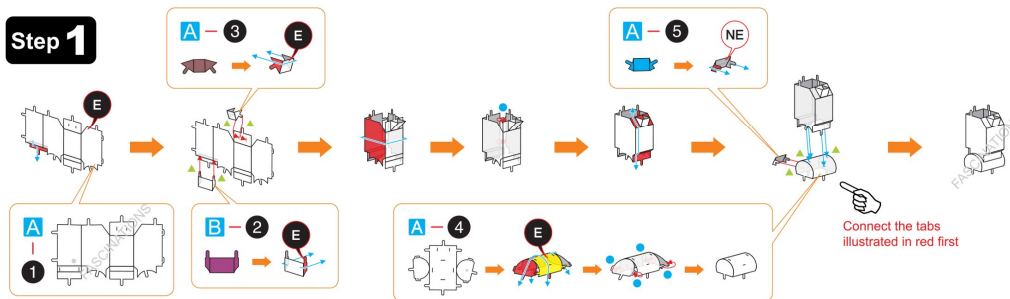

Connect the tabs illustrated in red first

Step 2

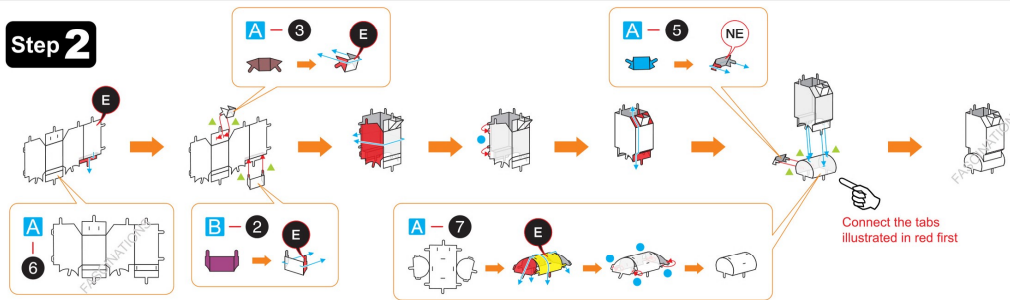

Connect the tabs illustrated in red first

Step 3

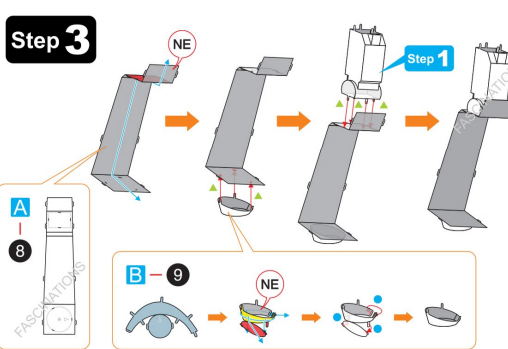

Step 4

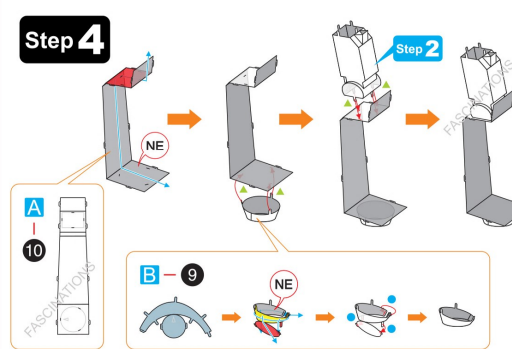

**Step 5**

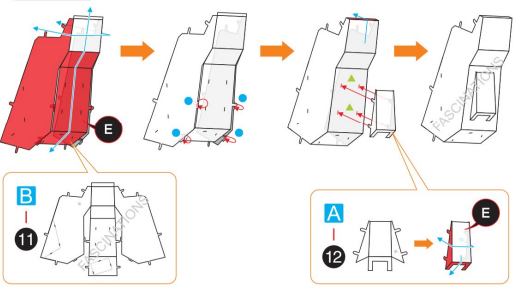

**Step 6**

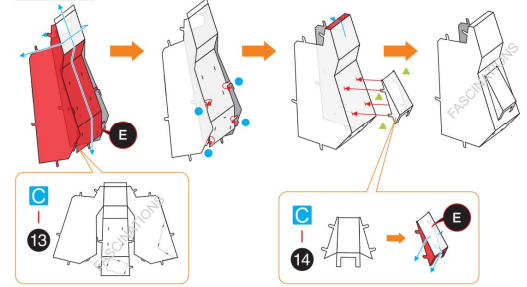

**Step 7**

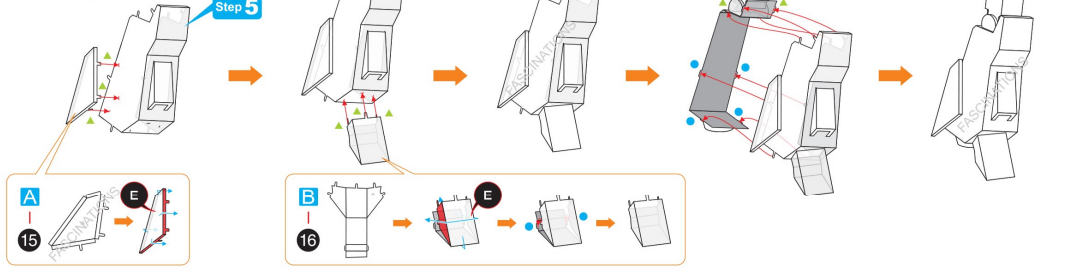

**Step 8**

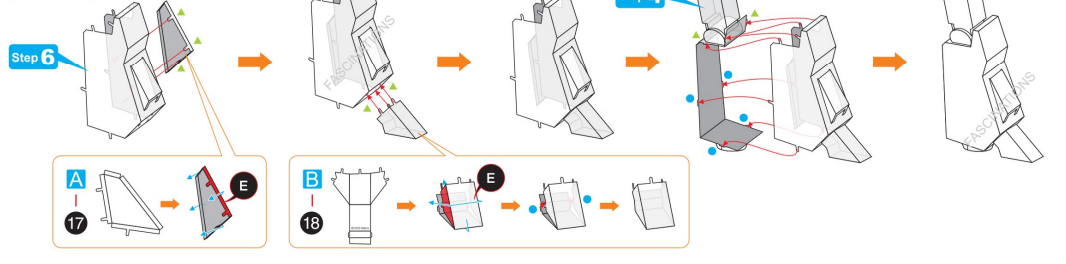

**Step 9**

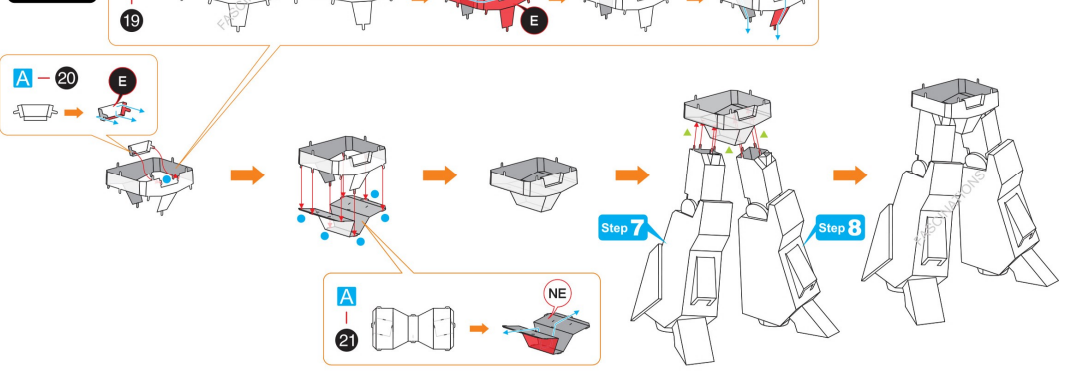

**Step 10**

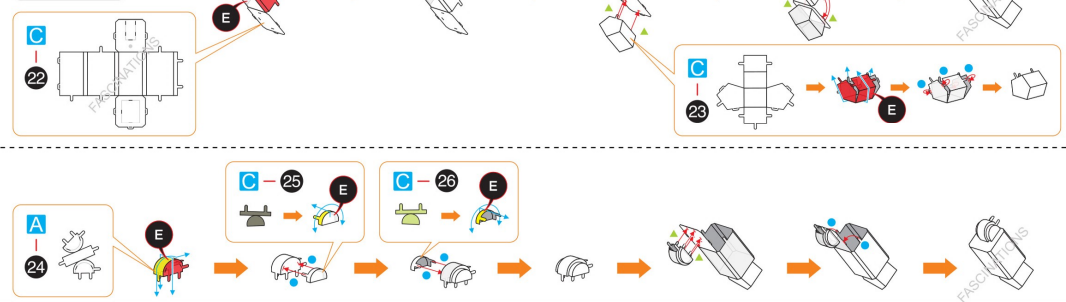

**Step 11**

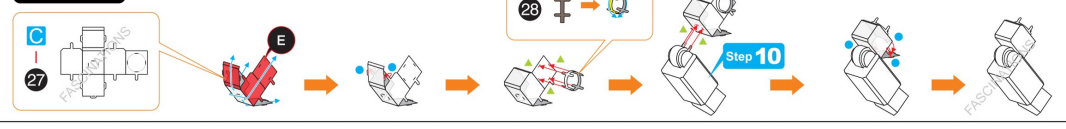

**Step 12**

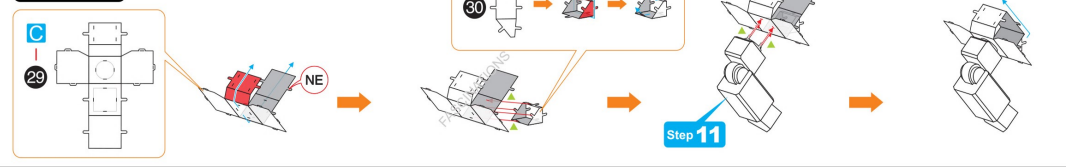

**Step 13**

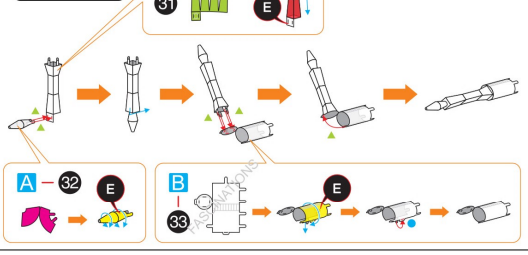

**Step 14**

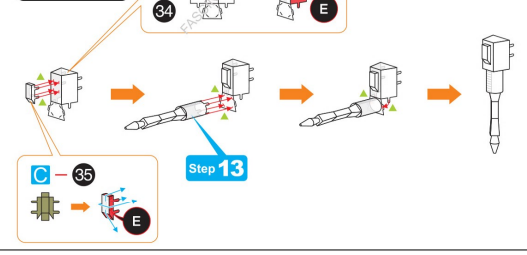

**Step 15**

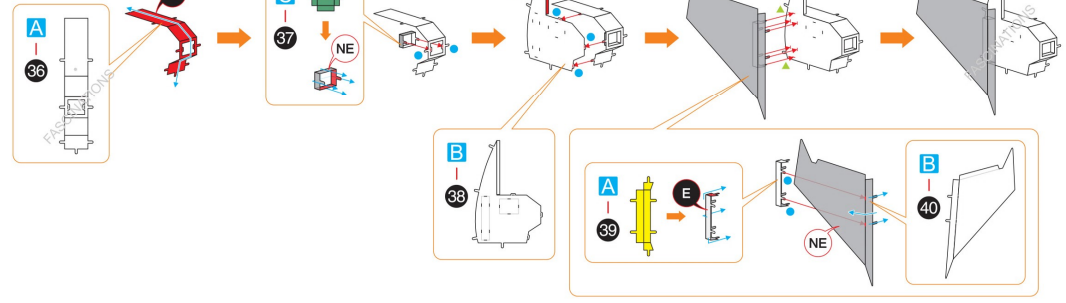

### Step 16

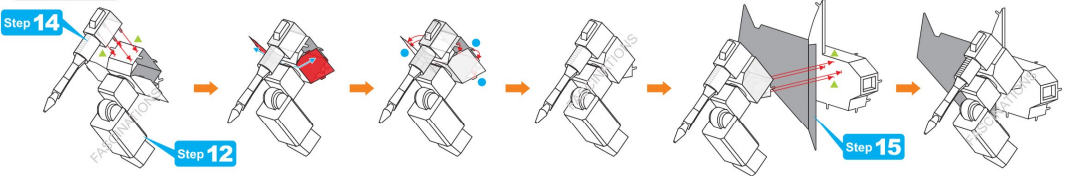

### Step 17

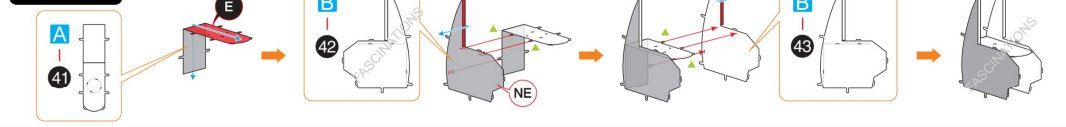

### Step 18

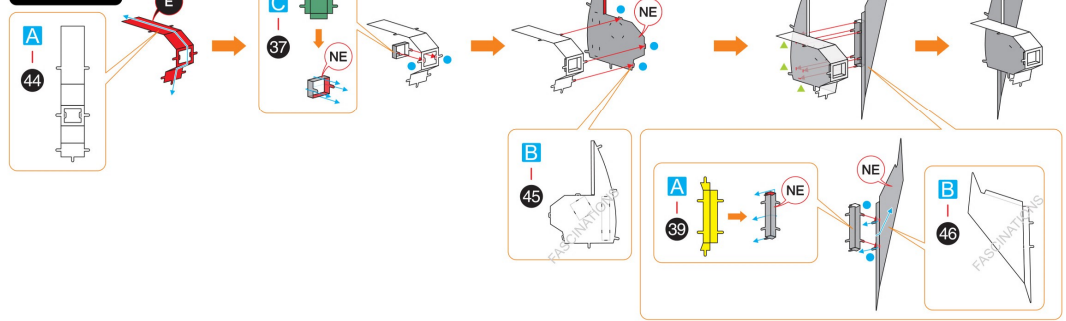

### Step 19

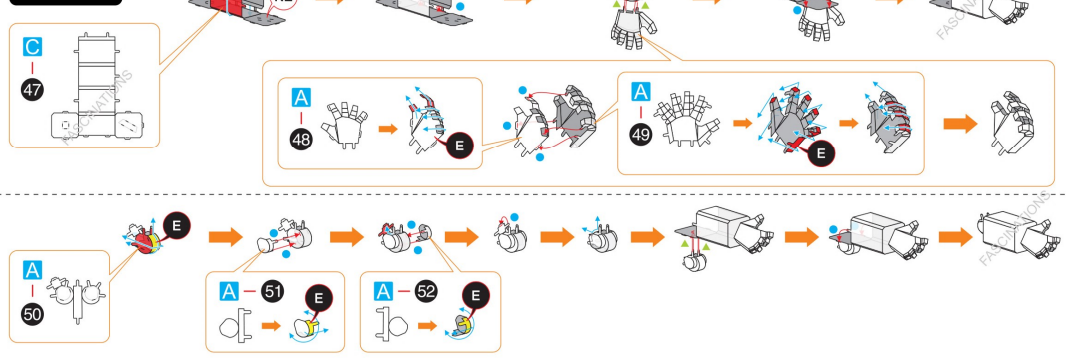

### Step 20

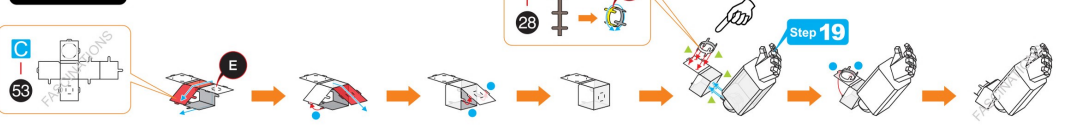

### Step 21

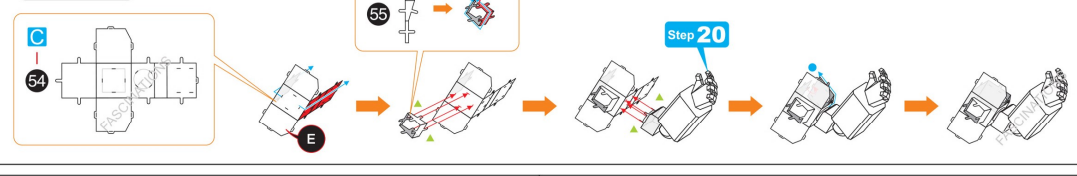

### Step 22

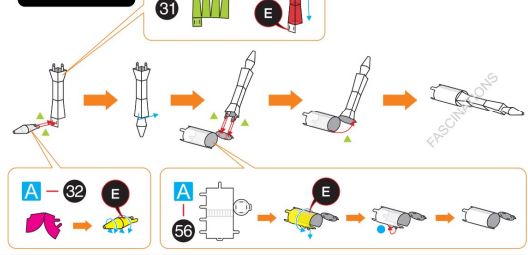

### Step 23

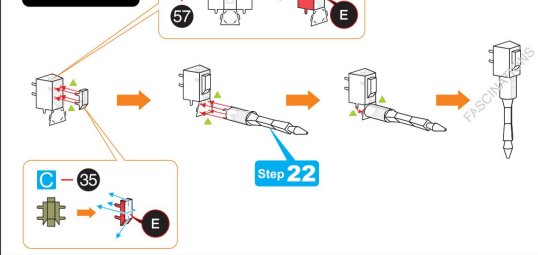

### Step 24

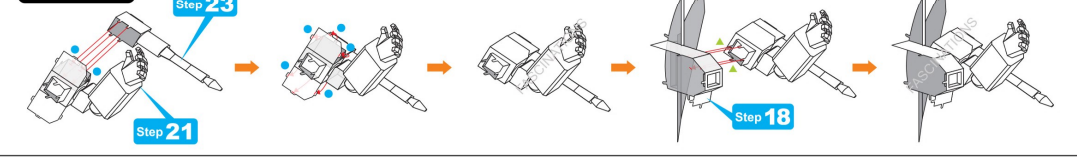

### Step 25

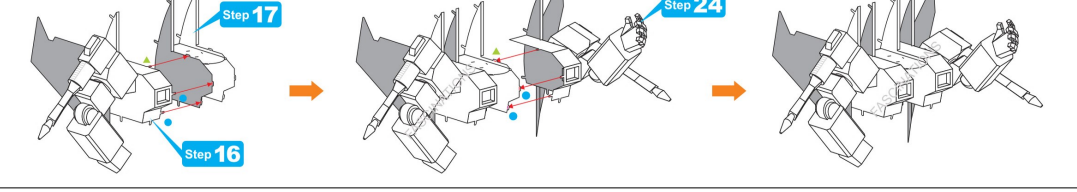

### Step 26

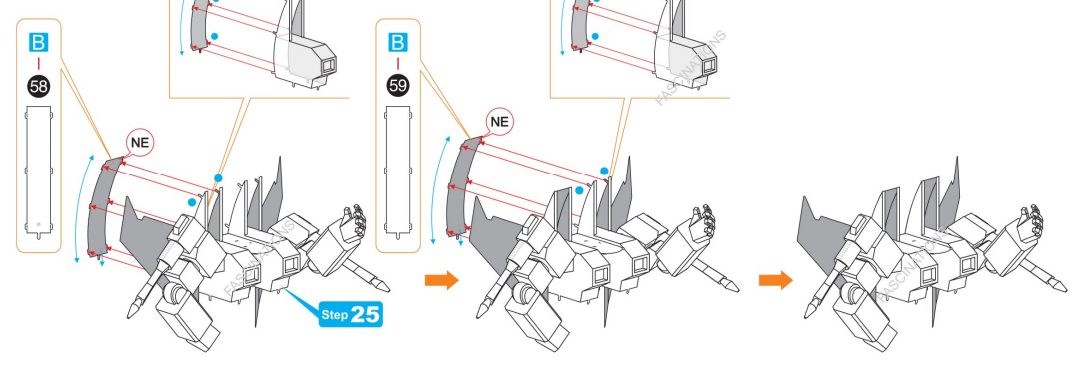

### Step 27

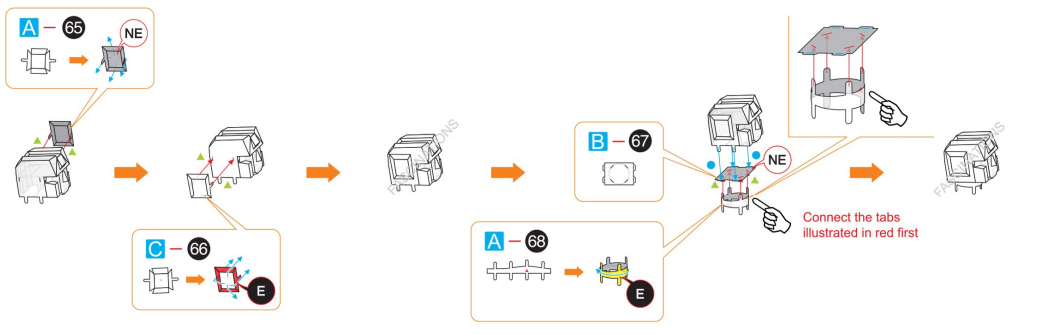
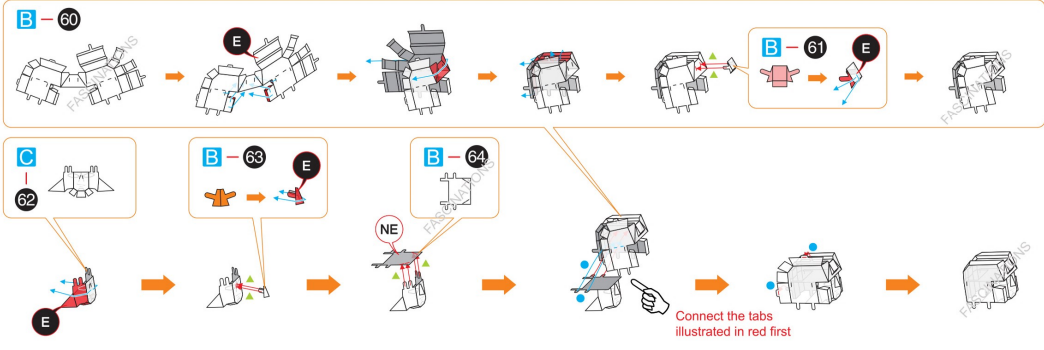

### Step 28

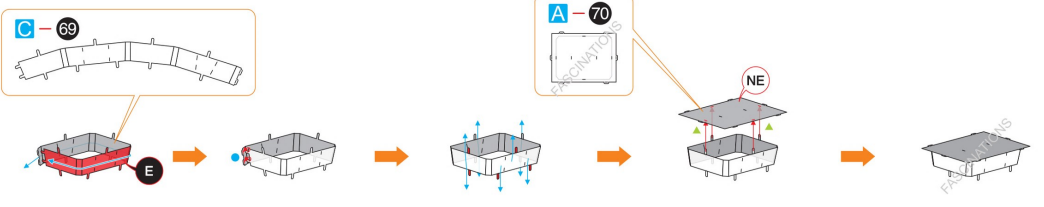

### Step 29

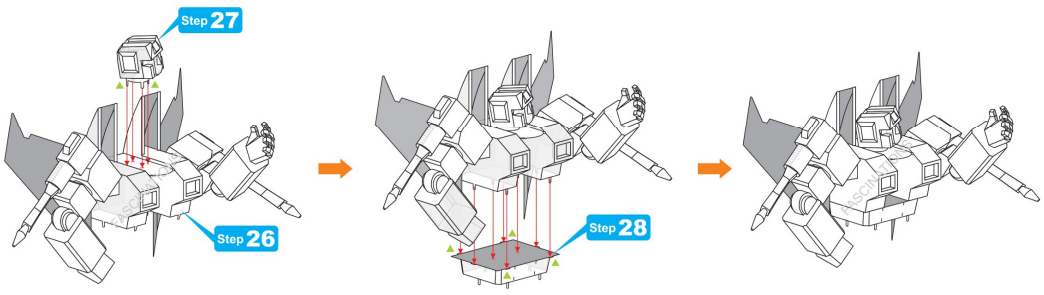

### Step 30

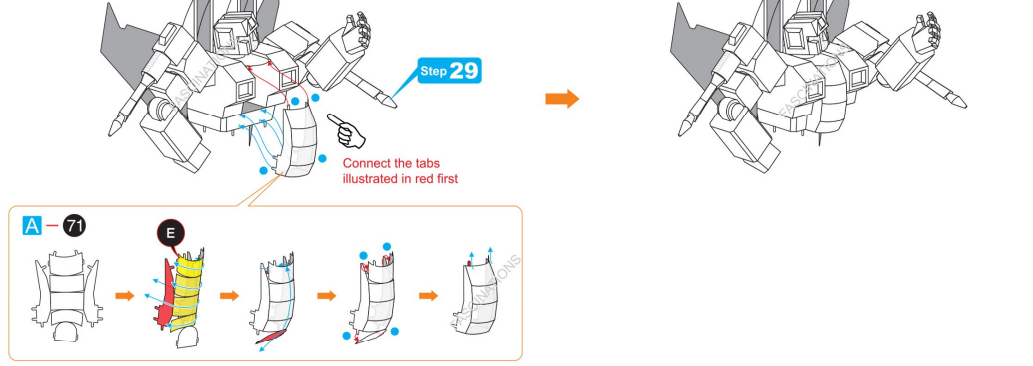

### Step 31

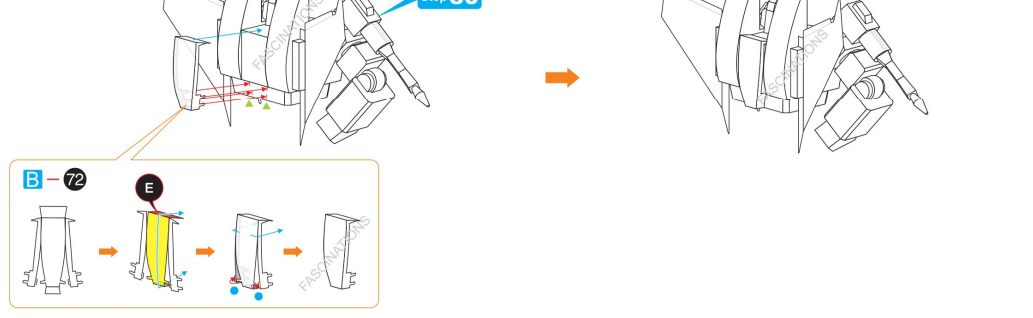

### Step 32

