

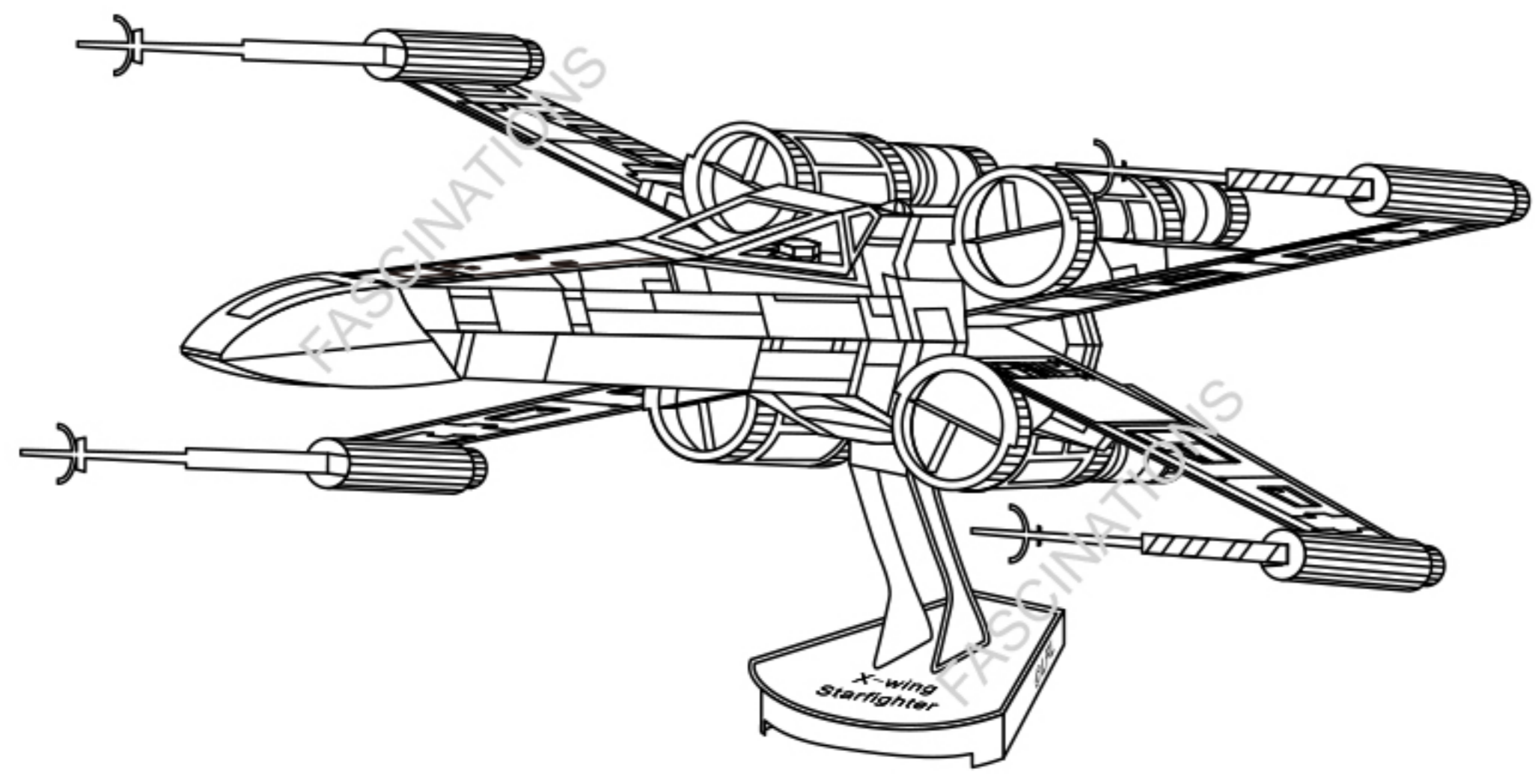

www.starwars.com
© &™ Lucasfilm Ltd.



3D METAL MODEL KITS



X-wing Star Fighter™

Item No. MMS257



It is highly recommended that you visit www.metalearth.com/360/mms257 to see the completed model before assembling your own

Legends:

- Engraved side
- Non-engraved side
- Attention point
- Insert tab and bend 90 degrees
- Insert tab and twist 90 degrees

Recommended tools:

-Wire cutters: helpful for taking parts from the metal sheets.

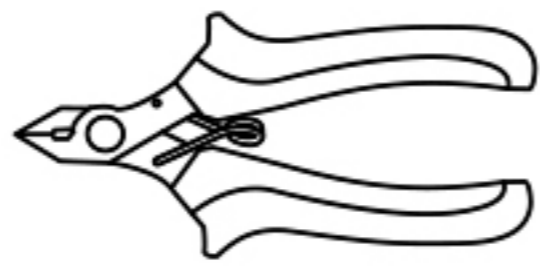

-Tweezers or needle nose pliers: helpful for folding parts, bending and twisting tabs.

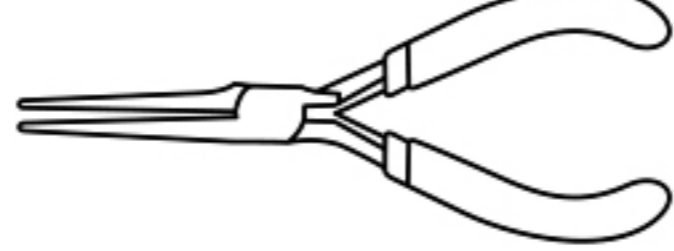
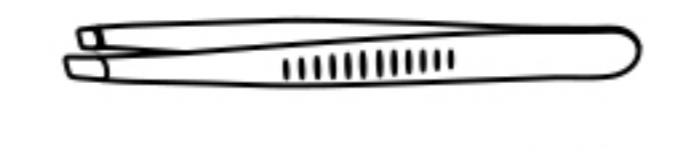

Assembly tip:

If needed, slightly twist tabs to hold parts together then untwist and bend them down for a nice finish

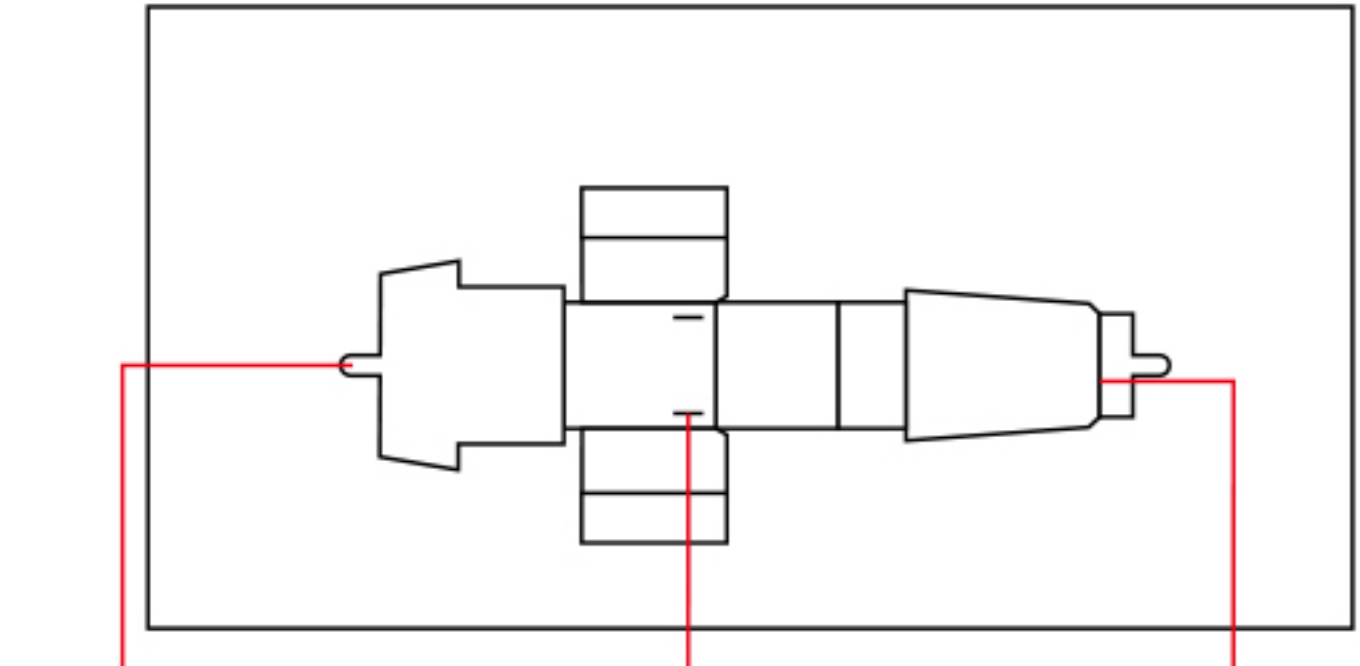

Insertion tabs are inserted and then folded

Insertion holes

Fold lines can be seen as shown here

Metal sheets

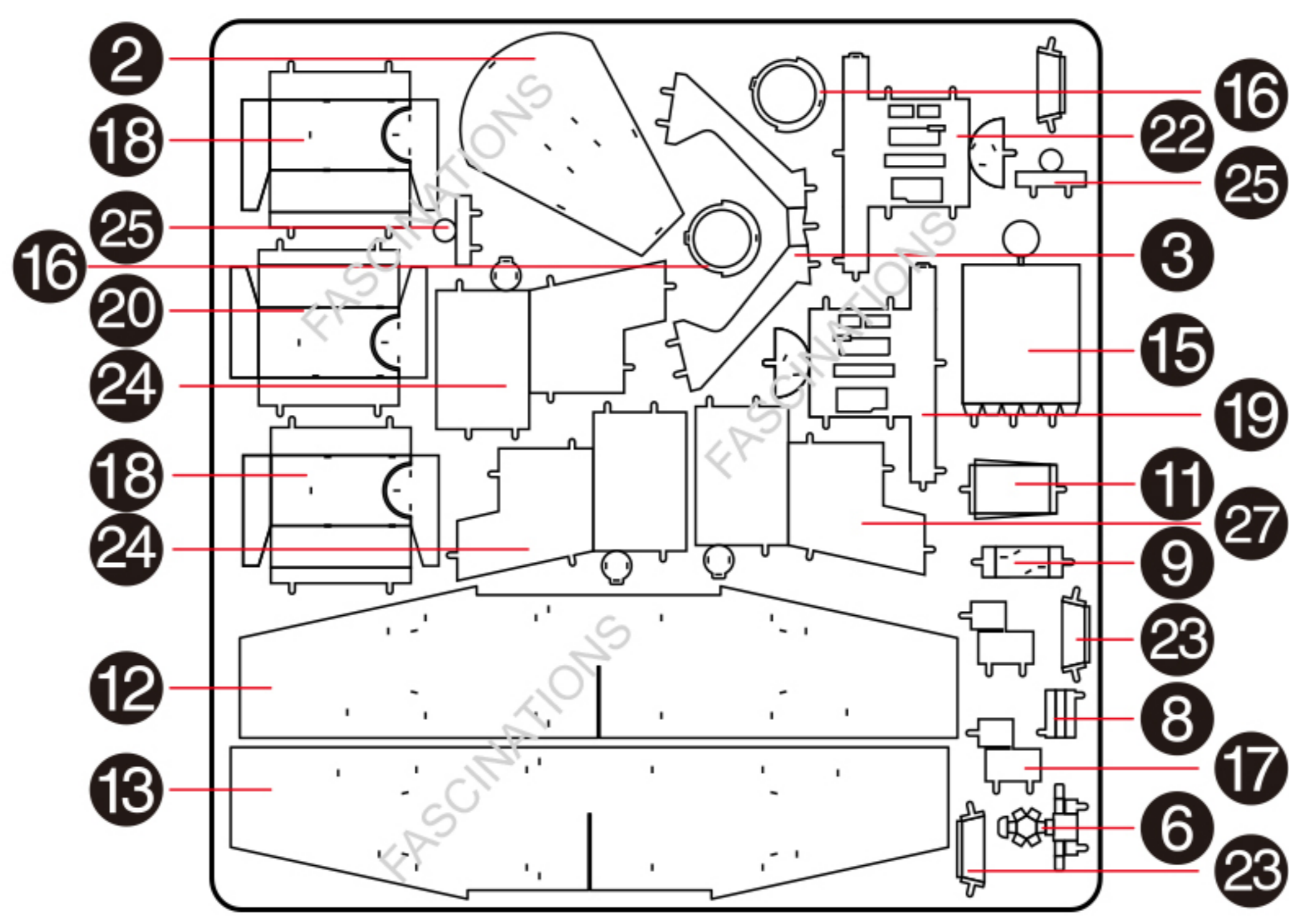
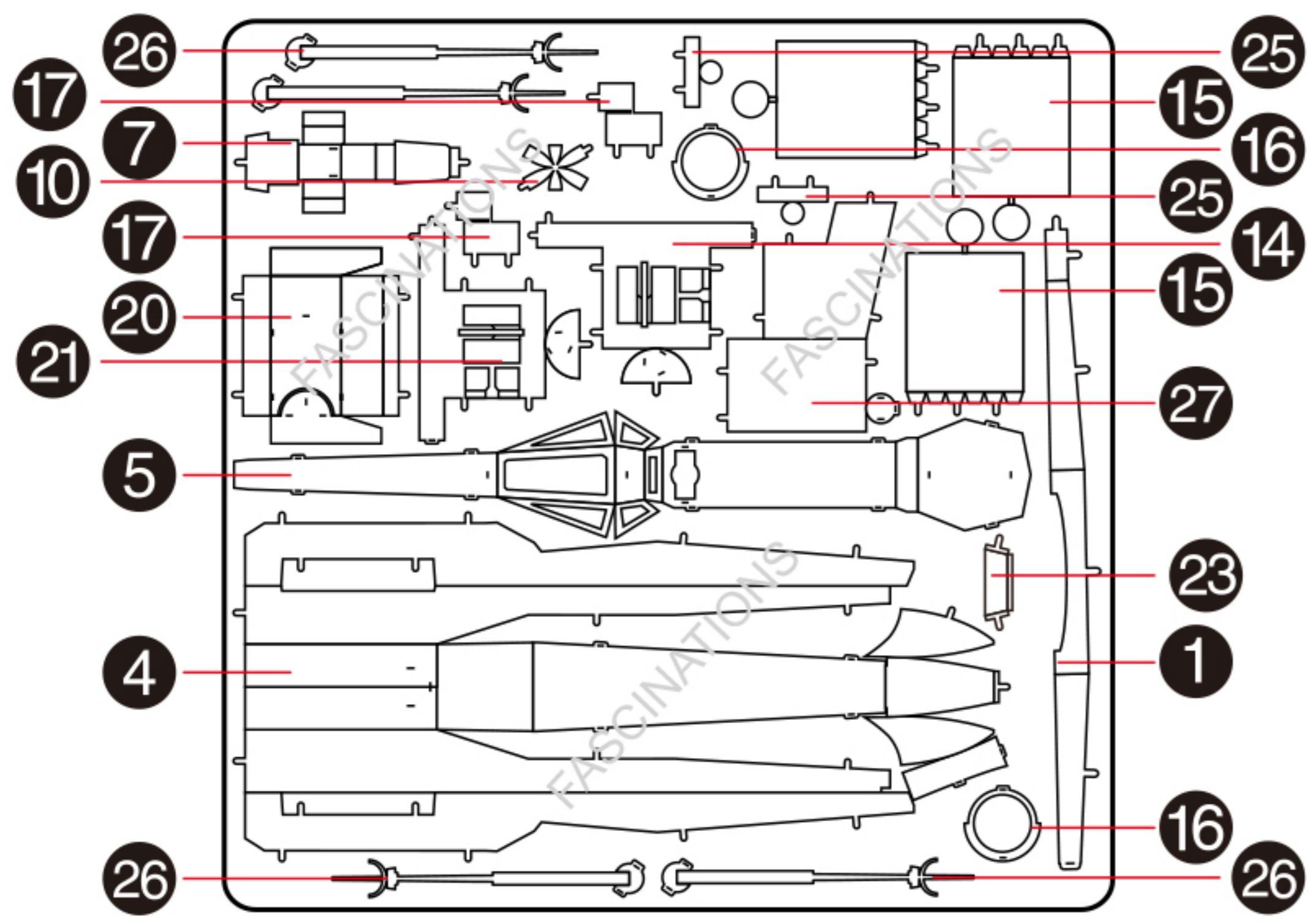

In order to avoid possible injury from sharp edges, please carefully discard the metal sheet after parts have been removed

Assembly Flow Chart

