

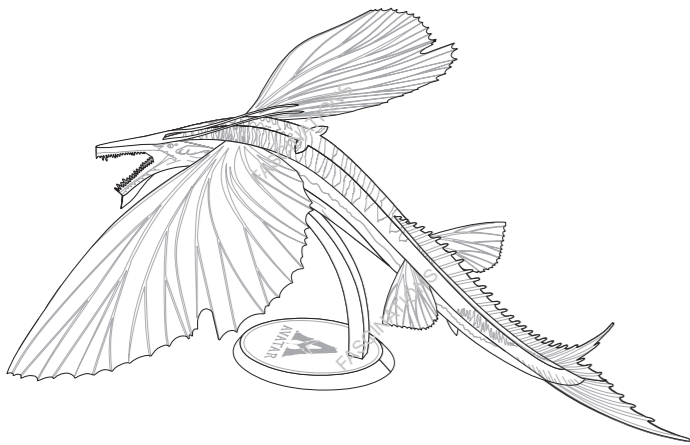

It is highly recommended that you visit www.metalearth.com/360/ICX242 to see the completed model before assembling your own



ICX242 Skimwing



TO CREATE THE BEST CONNECTIONS

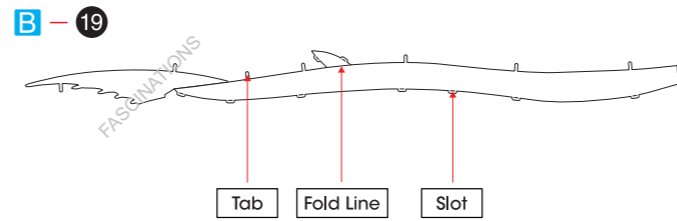

Legends:

- E** Engraved/ Color side
- NE** Non-engraved/ Silver side
- Attention point
- Insert tab and bend 90 degrees
- Insert tab and twist 90 degrees

Assembly tip:

If needed, slightly twist tabs to hold parts together then untwist and bend them down for a nice finish.

- Yellow areas should be curled
- Red areas should be folded



In order to avoid possible injury from sharp edges, please carefully discard the metal sheets after parts have been removed.

Recommended tools:

- Wire cutters: helpful for taking parts from the metal sheets.



- Tweezers or needle nose pliers: helpful for folding parts, bending and twisting tabs.



METAL SHEETS

Parts with same color are duplicates

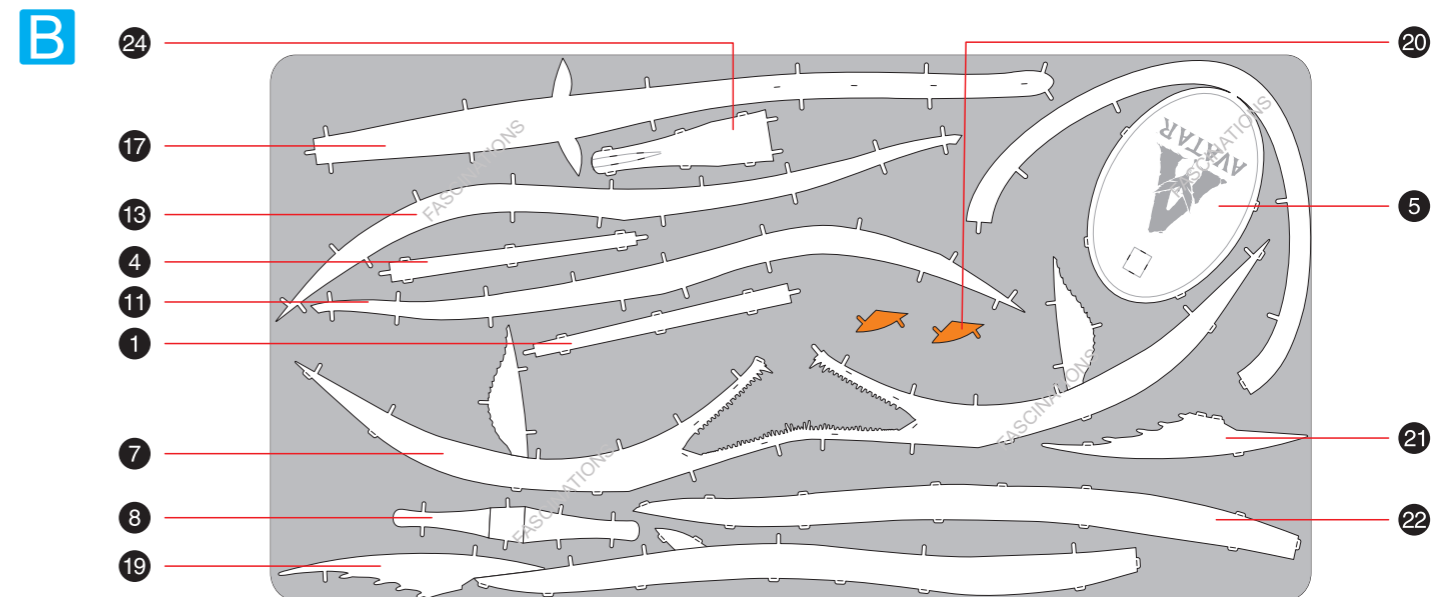
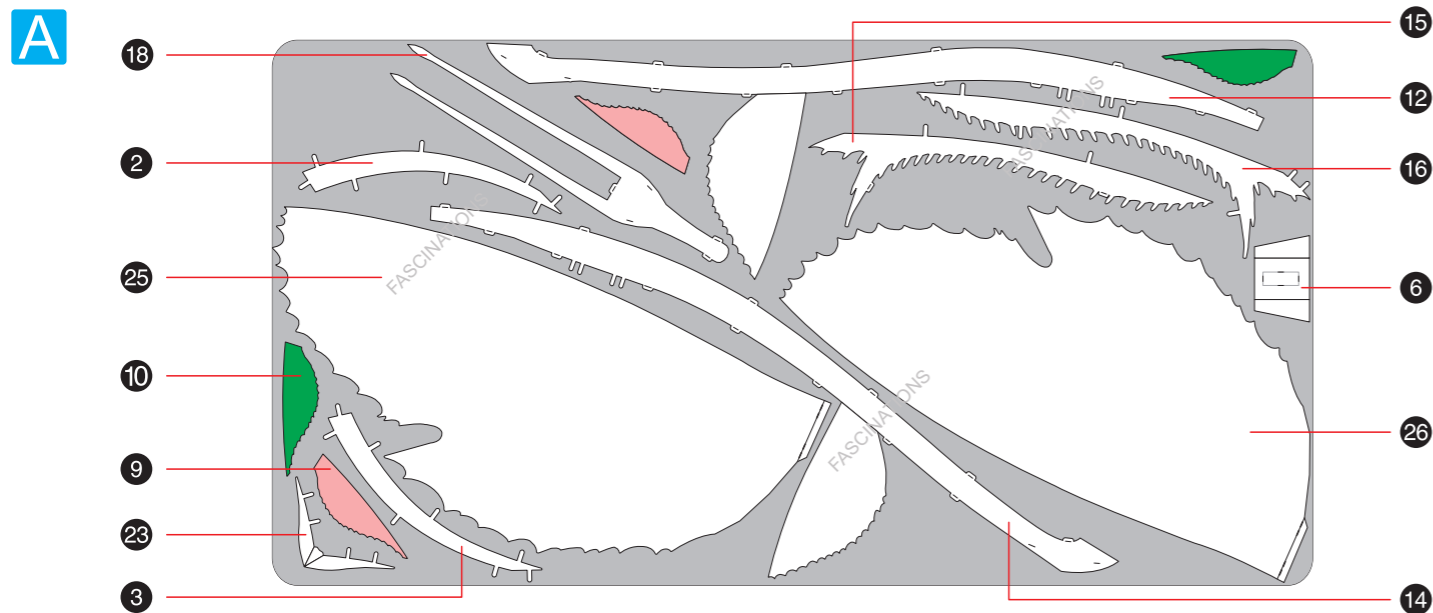

ASSEMBLY STEPS

Step 1

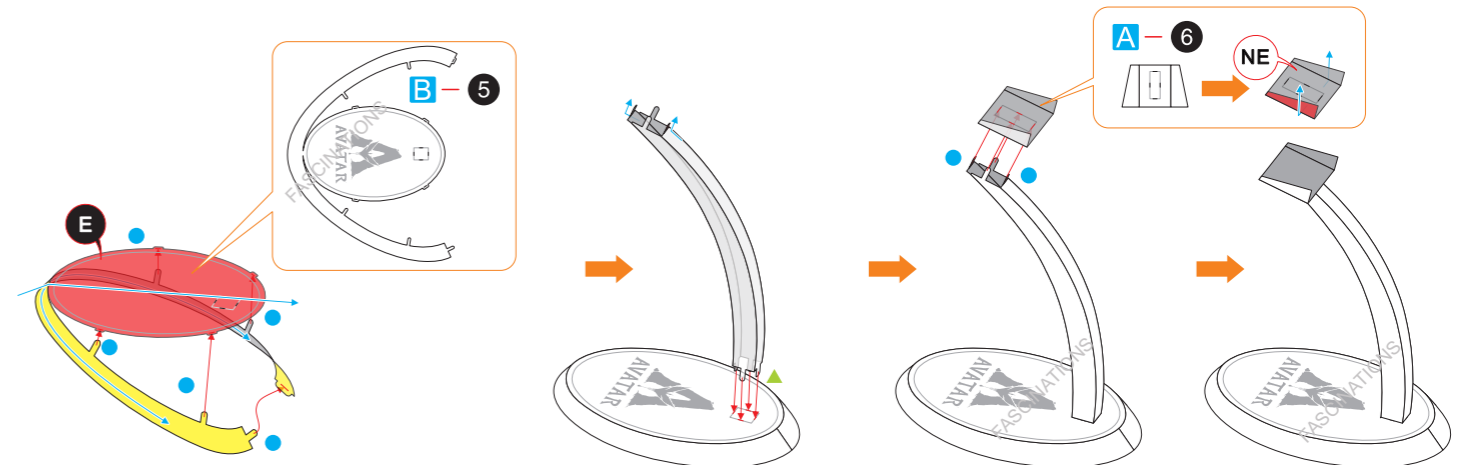
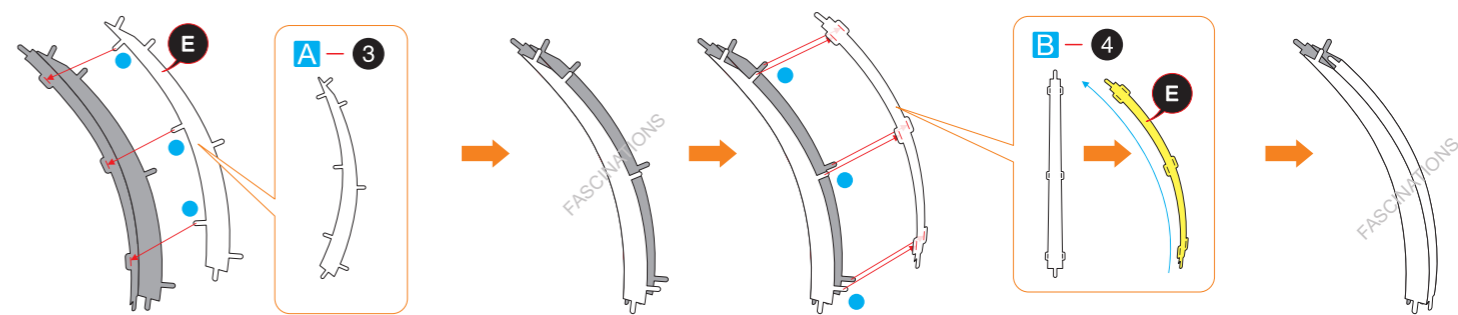
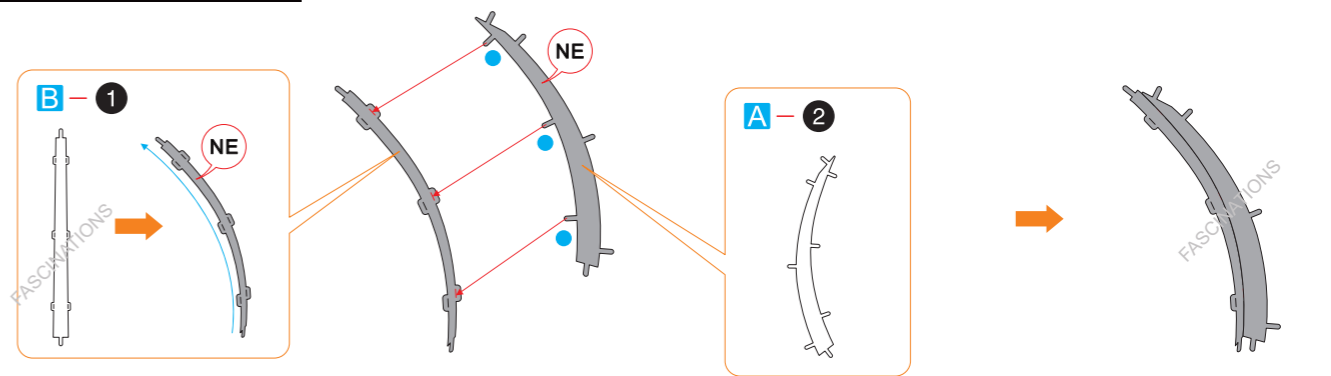

Step 2

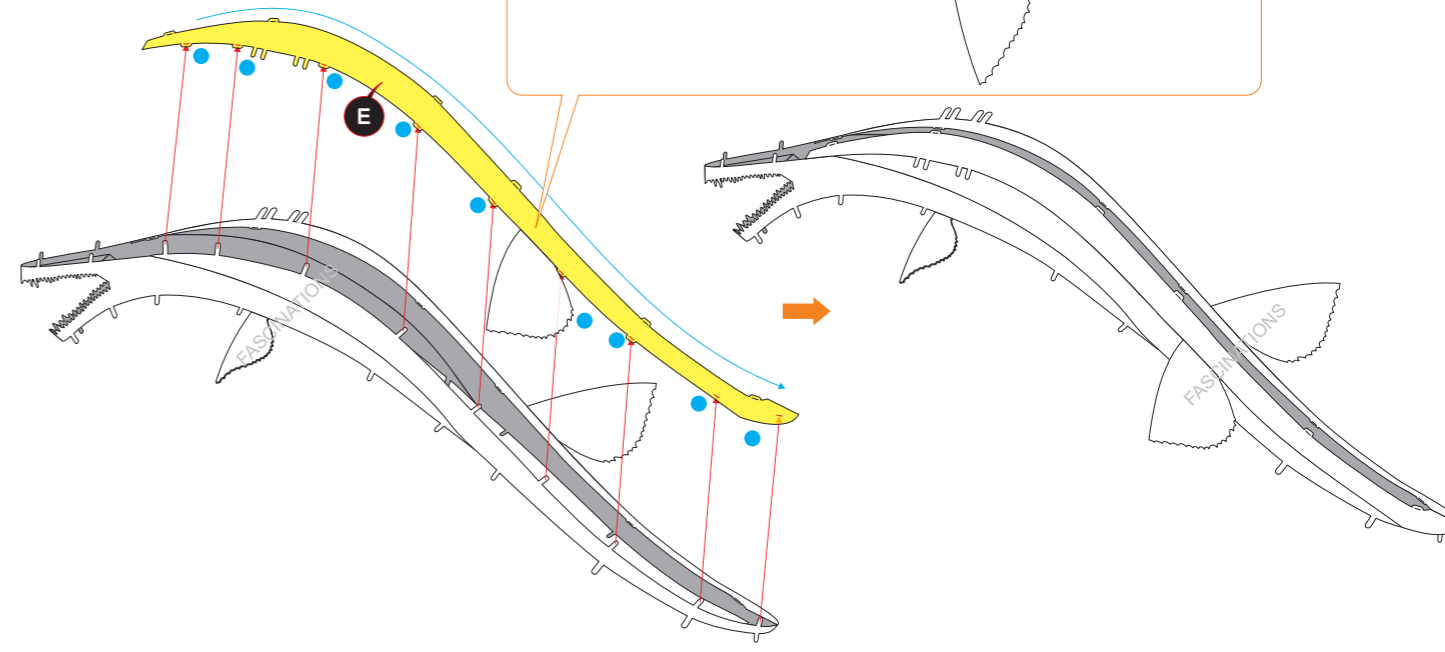
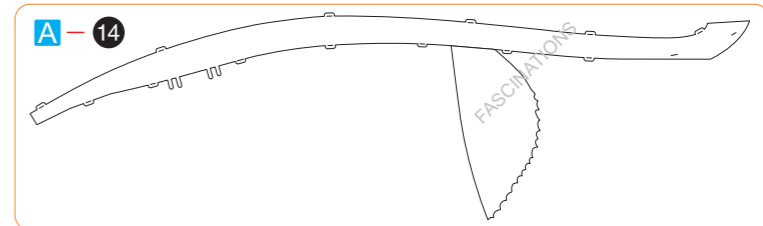
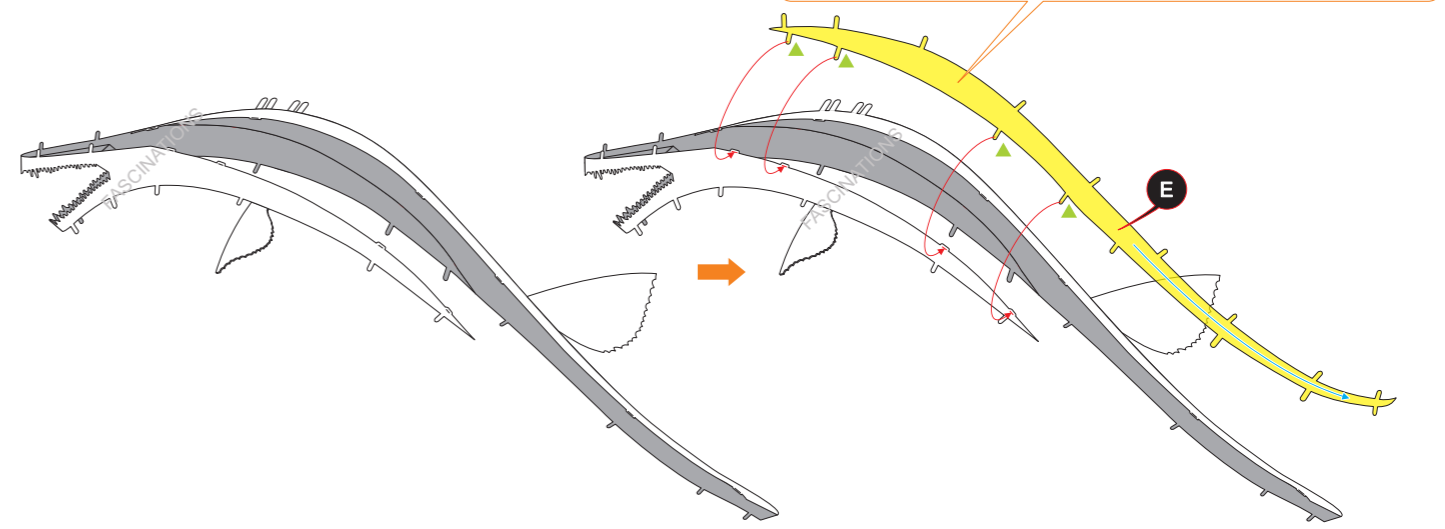
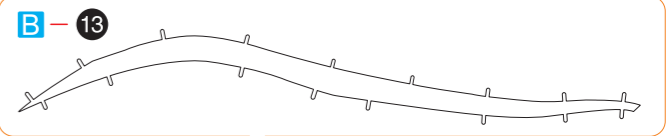
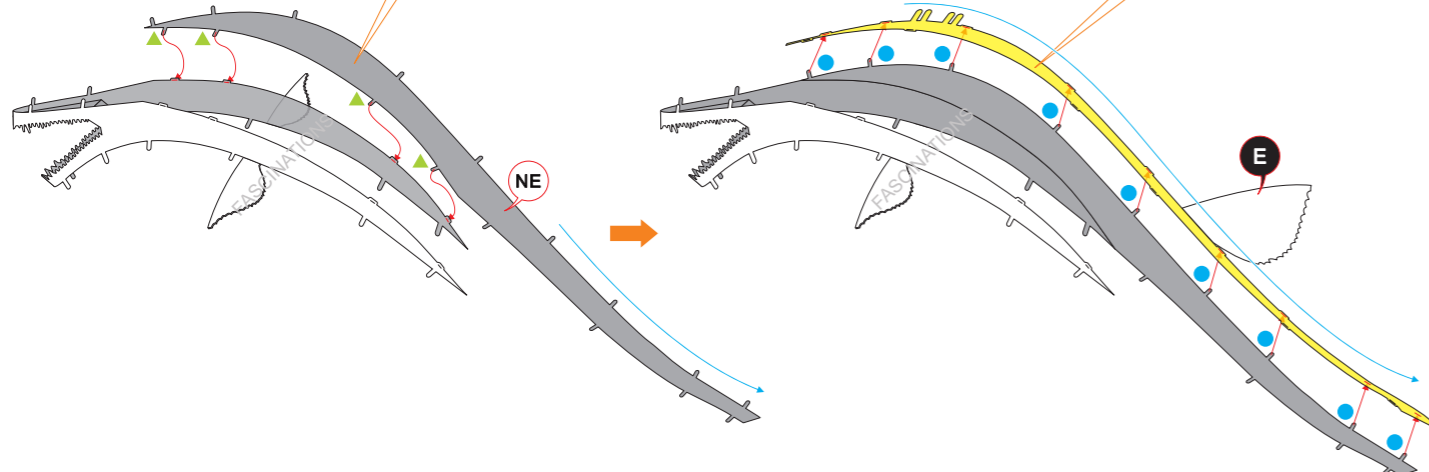
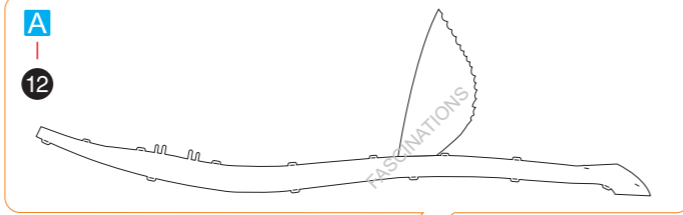
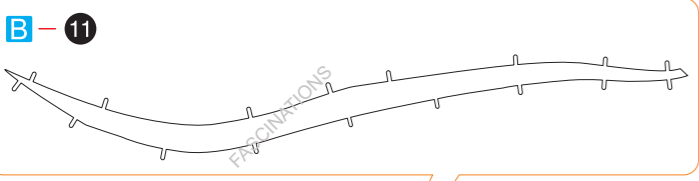
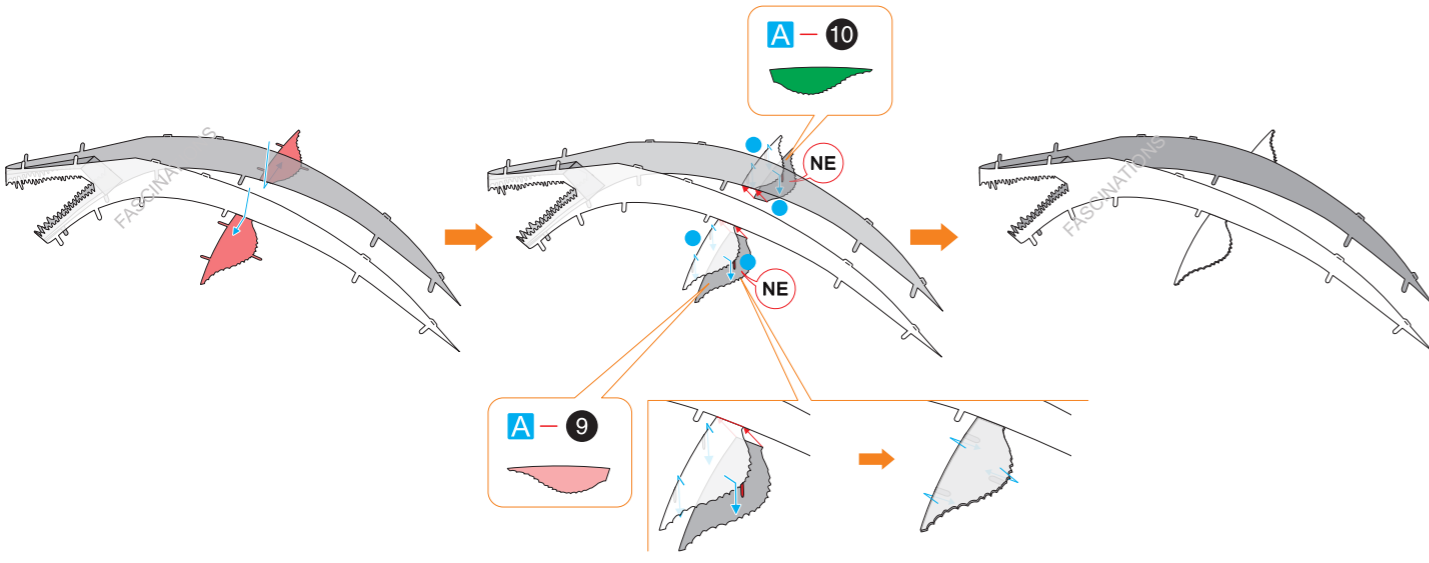
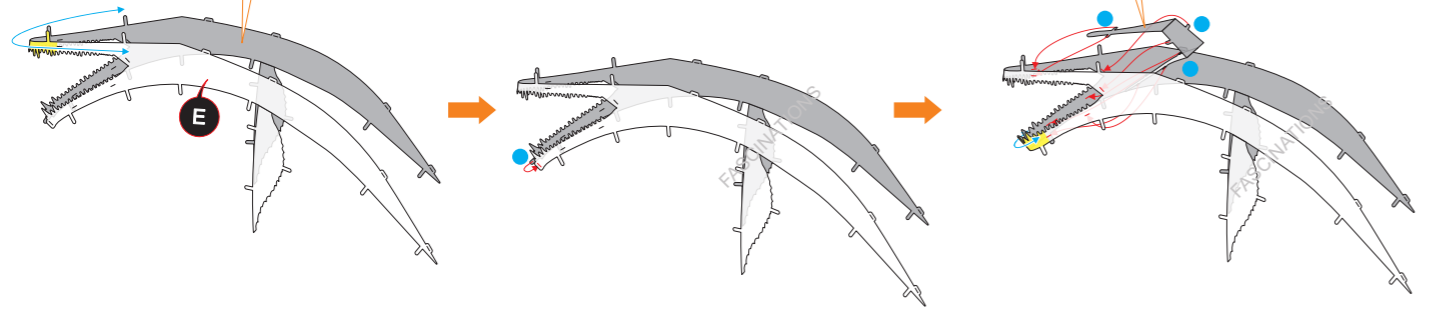
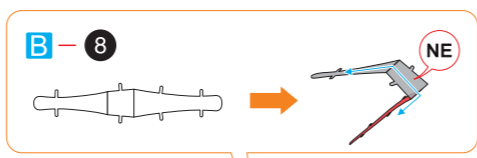
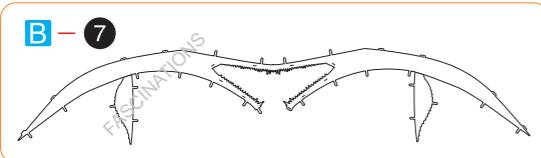

Step 3

